

Intelligent Solar Charge Controller

User's Manual

Catalogue

- I. Product Introduction (P1)**
- II. Installation (P1)**
- III. Operation (P3)**
- IV. Common Breakdown and Disposal (P6)**
- V. Technical Data (P7)**

Please read this manual carefully before you use this product.

I. Product Introduction

This controller is a kind of intelligent, multi-purpose solar charge and discharge controller. These serial products adopt customized LCD display screen, which makes the operation on the interface rather convenient. All the controlling parameters can be reset flexibly to satisfy your different needs. This controller has the following features:

● Visual LCD graphic symbol	● Brief key operation
● Automatic identification system voltage level	● Intelligent PWM charge mode
● Automatic temperature compensation	● Adjustable charge-discharge control parameters
● Settable operating modes of loads	● Overload & short circuit protection
● Remote monitoring and control function (customized)	● Battery reverse-discharge protection
● Battery low voltage disconnection (LVD)	● Battery reverses connection protection
● Cumulative function of charge and discharge	● Double USB and LCD output (optional)

II. Installation

① Get ready the related tools and cables. We suggest you to choose the right cables. Recommendation: 20A, 30A using 16mm² cable, 40A, 50A, 60A using 25mm² cable. Check whether the installation place accords with the relative safety requirements. Please avoid installing and using the controller under the following conditions: damp, dusty places or places with

flammable, explosive and corrosive gases.

② This device is made for solar panel charging. PV port MUST connect to solar panel. DON'T connect to other electric sources, or lead to unexpected occasion.

③ Install the controller into a fixed vertical plane. Please refer to Chapter 5 for more detailed info about the spacing between the installing holes. In order to make the controller have a good thermal condition, please spare 10cm above & below the controller.

④ As shown on the right, connect the (1) Loads, (2) Battery and (3) Solar Panel with the controller in order. Pay attention to connect the loads, battery, solar panel and controller of same polarity.

⑤ Put the external thermal sensor into the interface of thermal-sensor on the left of the controller. The temperature sensor should be similar space with battery. (Otherwise, the controller will control the parameters of all wrong temperature compensation.)

⑥ If you have remote monitoring and control function, please insert one end of the included communication wire on the right of the controller (communication port), the other end to connect to the host computer.

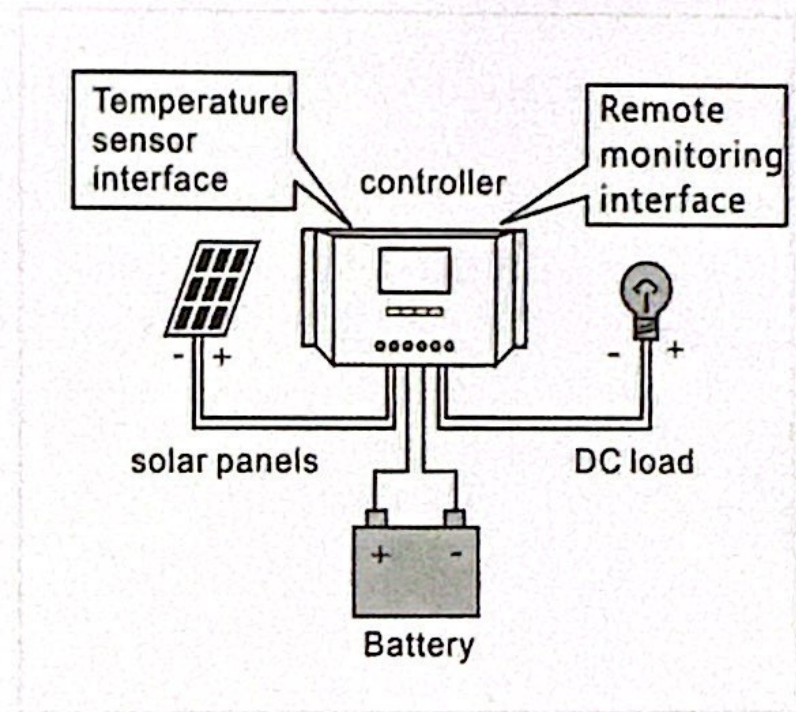













Demolition: To avoid the accident, please dismantle solar panels, battery and loads from the controller. in order.

Attention : Connecting the battery reversed will not damage the controller, but will cause safety risk on your loads.

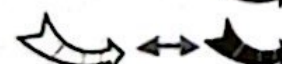

III. Operation

1. Description of LCD graphic symbol

-  Stop supplying power for Loads
-  Supplying power for Loads , the load circuit without current
-  The load circuit with current
-  Load
-  Solar Panel
-  Load sensor control
-  Load timer control



-  Stop the battery charging
-  Bulk charging the battery
-  Float charging the battery
-  The system is working correctly
-  The system is not working correctly
-  Battery charge capacity display
-  Battery

2. Description of button function:

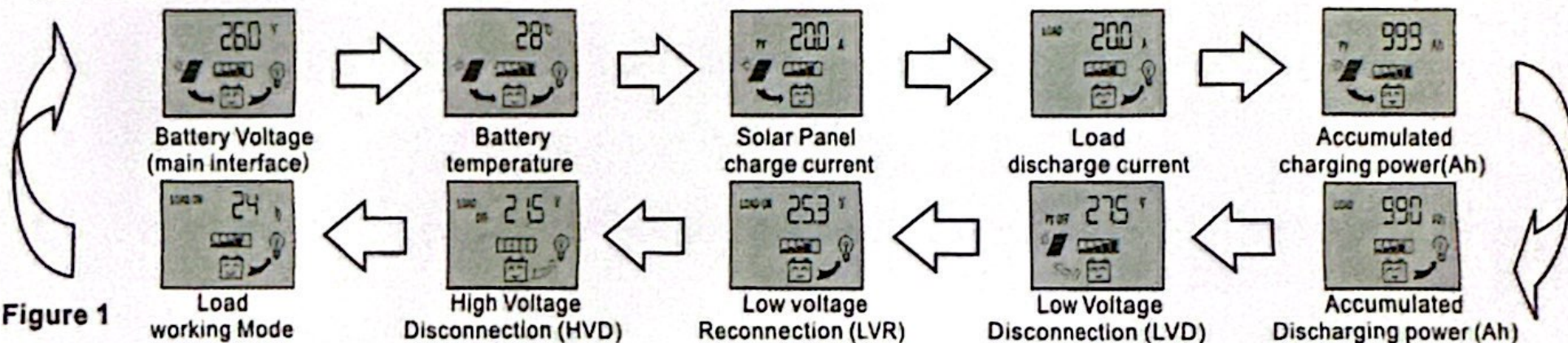
-  : Interfaces circular toggling button. Use this button can realize the toggling circularly among the interfaces. The circular order is as follows: as shown as figure 1
-  : Adjustment of parameters plus buttons. Besides, under parameter view condition, press the button for over 5 seconds, and all the parameter will recover to the ex-work setting state.
-  : Adjustment of parameters minus button. Besides, at the main interface, this button can turn on or turn off the load.



3.View and set the parameters

After the controller electrifies right, it will enter into the displaying interface of batter voltage. This interface is the main interface of the controller. Press the button  to go through the interface of the following parameters. If that interface could be reset, press the button  for long (>5seconds and the number on the interface start to flicker) , then it enter the setting interface of this parameter. After finishing the setting, press the button  for long to exit the setting interface, and the number stop flickering.

3.1 Battery Voltage review

As shown as the right figure, the displaying number is the present battery voltage. This interface is the main interface, and it shows the charging & discharge state, battery capacity and battery voltage.



3.2 The load On/Off controlling

At the batter voltage review interface, you can press button  to turn on or turn off the load, While this button does not have this function at other interface.



3.3 Environmental temperature review

As shown on the right, displays the ambient temperature of the controller, the value used for temperature compensation on LVD function. The sensor must be plug in before using the controller.



3.4 Review the generating current of solar panels

As shown as the right figure, the displaying number is the generating current of solar panels.



3.5 The load current review

As shown as the right figure, the displaying number is the load current.

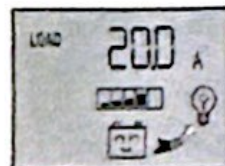

3.6 Review and clearing the accumulative generating AH of solar panels

As shown as the right figure, the displaying number is the accumulative generating AH of solar panels. At this interface, press the button for long  (> 5seconds) , and it can clear accumulative generating AH.







3.7 Review and clearing load accumulative discharging AH

As shown as the right figure, the displaying number is the accumulative discharging AH of loads. At this interface, press the button  for long (>5seconds), and it can clear accumulative discharging AH.







3.9 Review and setting recovering voltage for low voltage condition

As shown as the right figure, the displaying number is the recovery number. After the controller enters into low voltage protection state, when the battery voltage recovers to be higher than the recovery voltage, then the controller will reconnect the load loop automatically. At this interface, press the button  for long (>5seconds), the number starts to flicker, and it means the controller enters into the interface of setting the recovery voltage. Use the key /  to adjust this parameter. After finishing setting, press the button  for long (>5seconds) to exit this interface and the controller can store this setting number.







3.8 Review and setting the voltage of ceasing charging

As shown as the right figure, the displaying number is the voltage of ceasing charging. When the battery voltage reaches up to this voltage, the controller will disconnect the charging loop to prevent the battery from overcharging. After the battery voltage drops, the controller will reconnect the charging loop. At this interface, press the button  for long (>5seconds), the number starts to flicker, and it means the controller enters into the interface of setting the voltage of ceasing charging. Use the key /  to adjust this parameter. After finishing setting, press the button  for long (>5seconds) to exit this interface and the controller can store this setting number.



3.10 Review and setting low voltage protection function

As shown as the right figure, the displaying number is the protection voltage. And if the battery voltage is lower than protection voltage, the controller will disconnect the load loop to prevent battery from over-discharging. At this interface, press the button  for long (>5seconds), the number starts to flicker, and it means the controller enters into the interface of setting the protection voltage. Use the key /  to adjust this parameter. After finishing setting, press the button  for long (>5seconds) to exit this interface and the controller can store this setting number.

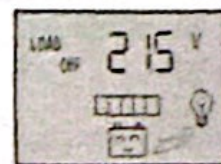

3.11 Review and setting the load mode





As shown as the right figure, it is the reviewing surface of the load mode.

Different numbers represent different load mode.

24h—indicating normal mode, loads are under the condition of supplying power without breakdown.

1h~23h—indicating delayed mode of light control, loads start to supply power after dark and shun down after working for the delayed setting hours

0h—said light control mode, loads start to supply power after dark and stop working after drawn.

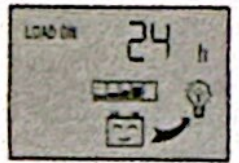

At this interface, press the button  for long (>5seconds) , the number starts to flicker, and it means the controller enters into the interface of setting the load modes. Use the key /  to adjust this parameter. After finishing setting, press the button  for long (>5seconds) to exit this interface and the controller can store this setting number.



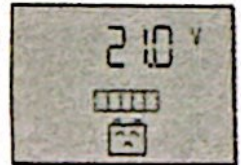

IV. Common Breakdown and Disposal

1. Low voltage protection and disposal: If the screen shows as the right figure, it means the battery voltage is lower than the protection voltage. The controller enters into the low voltage protection state and the load loop disconnects. Use the solar panels or charger to charge for the battery .When battery voltage recovers to the protection voltage, the controller will recover to supply power for load and enter into the working state.



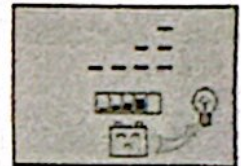

2. Overloading protection and disposal: If the screen shows as the right figure, and the light flickers, it mean the current of the load loop is 1.2 times of the rated current within 3 seconds, and The controller is at overload state. After removing some loads, the controller will supply power to the loads automatically within seconds, or you can press / button to recover the power supply compulsively.

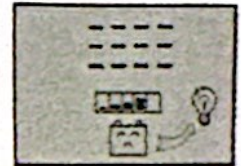

3. Short -circuit protection and disposal: If the screen shows as the right figure, and the light flickers, it means there happens short-circuit in the load loop, and the controller is at short-circuit protection state. Please check whether the loads are damaged and whether the connecting cables are short-circuit. After eliminating the break down, press the button / to recover the power supply for the loads.



4. Breakdown and disposal of solar panels:  Sign flickering means the controller do not detect the existence of solar panels. Please check whether the connection with solar panels are in good condition, and check whether the cables connecting the solar panels and controller are in open-circuit condition.

5. Load impulsion breakdown: If the  flickers when you turn on the load, it means the starting impulsion current is more than twice of the rated working current. Please restart the controller for times.

V. Technical Data

Rated Voltage	12V/24V						48V				
Rated Current	10A	20A	30A	40A	50A	60A	20A	30A	40A	50A	60A
USB Output voltage	5V										
DC Output voltage	12V										
Voltage of solar panels	≤50V						≤100V				
Float charging voltage	13.7V/27.4V						54.8V				
Low voltage protection	10.5V/21V						42V				
Low voltage recovery	12.2V/24.4V						48.8V				
Characteristic	No load loss:≤10mA; Loop voltage drop:≤170mV;Temperature compensation:-4mV/Cell/°C										
Working Environment	Operating Temperature:-20°C~60°C; Storage temperature:-30°C~70°C; Humidity requirements:≤90%, no condensation										
Installation cable area	≤7# AWG (16mm ²)		> 3# AWG (25mm ²)				≤7# AWG (16mm ²)			> 3# AWG (25mm ²)	
	LD serices have 2 buttons, one for switching, other one for adjustment						CM serices have 3 buttons, switching and adjustment				

*Only some items have DC and USB functions, we reserve the right to change the parameters without prior notice.